



CITY OF HAWAIIAN GARDENS
DEPARTMENT OF COMMUNITY DEVELOPMENT
BUILDING AND SAFETY DIVISION
 21815 Pioneer Boulevard
 Hawaiian Gardens, Ca 90716
 (562) 420 2641

A-005

EFFECTIVE :
1-05-2015

ACCESSIBILITY DETAILS FOR TUBS AND SHOWERS

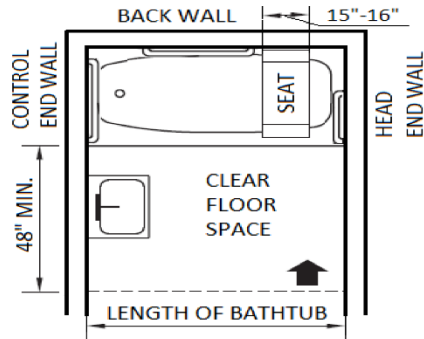

(a) REMOVABLE SEAT IN TUB - FRONT APPROACH

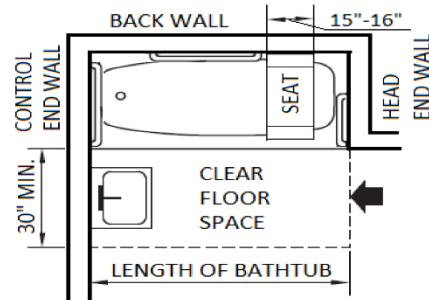

(b) REMOVABLE SEAT IN TUB - SIDE APPROACH

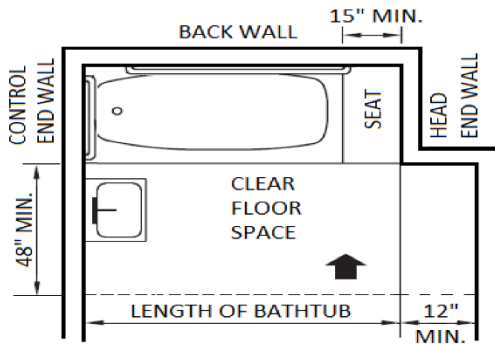

(c) PERMANENT SEAT IN TUB - FRONT APPROACH

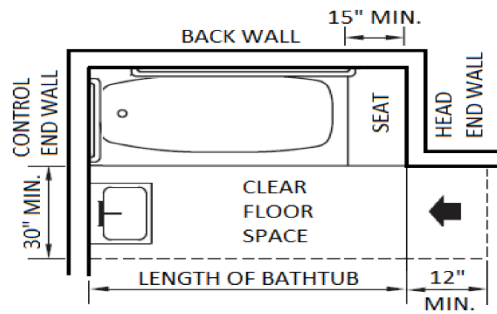

(d) PERMANENT SEAT IN TUB - SIDE APPROACH

NOTE: SEE FIGURE 11A-9F FOR SIZE OF GRAB BARS

FIGURE 11A-9E
CLEAR FLOOR SPACE AT BATHTUBS

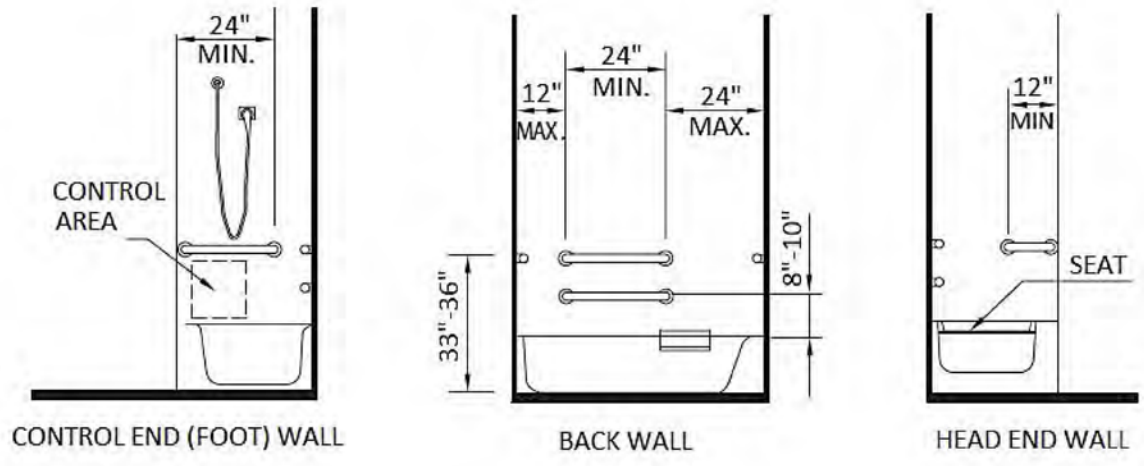

(a) WITH REMOVABLE SEAT IN TUB

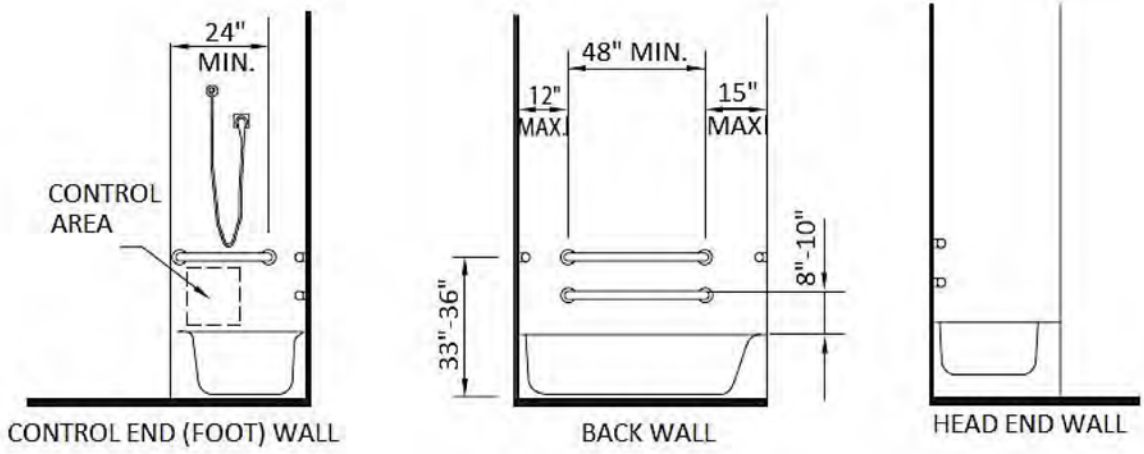

(b) WITH PERMANENT SEAT AT HEAD OF TUB

FIGURE 11A-9F
GRAB BARS AT BATHTUBS

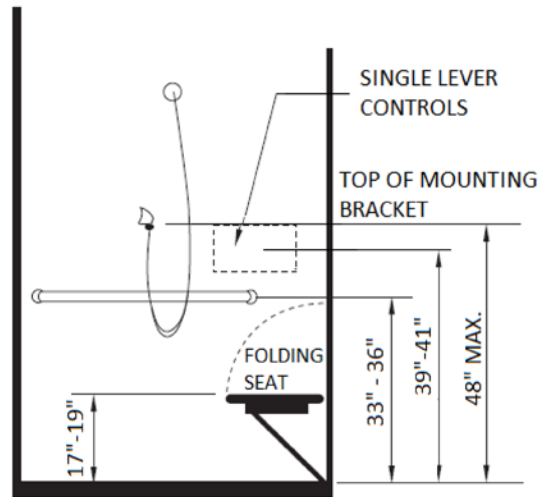
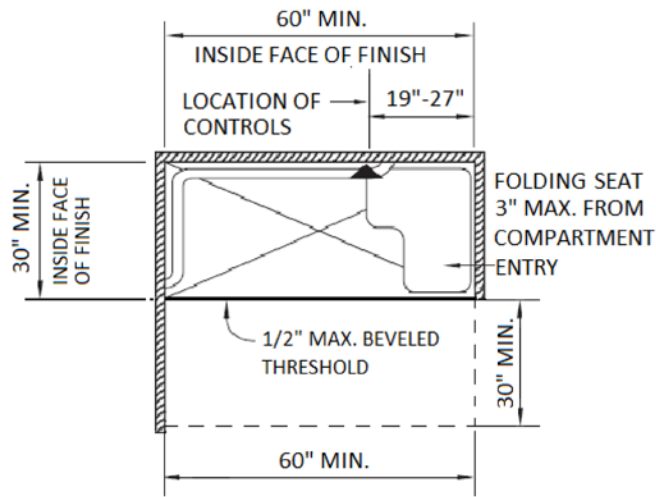

(a) 60" x 30" ROLL-IN SHOWER

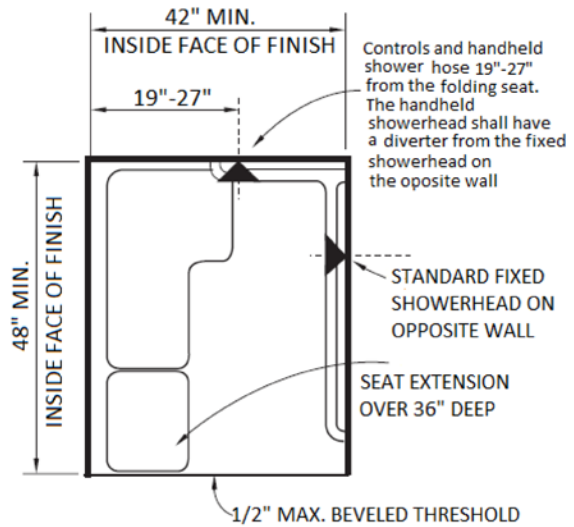
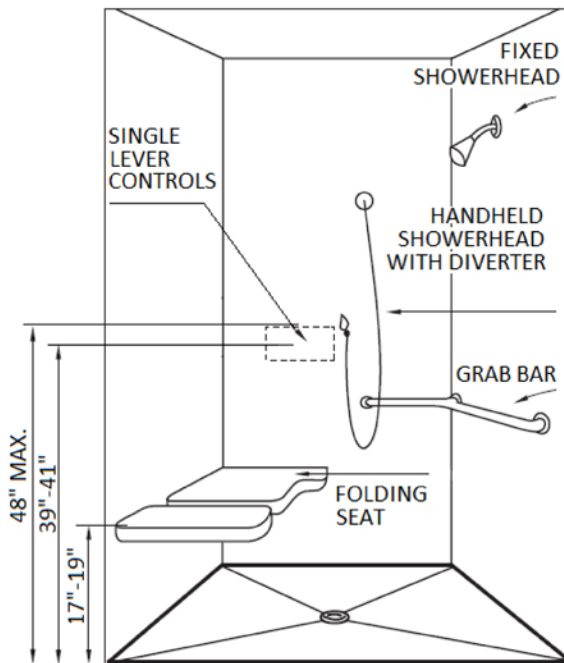

(b) 42" x 48" ROLL-IN SHOWER

**FIGURE 11A-9H
STANDARD ROLL-IN SHOWER**

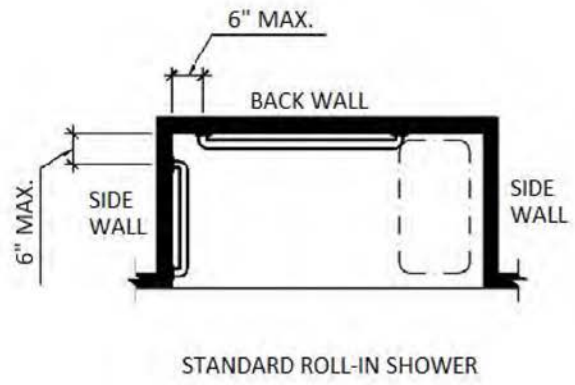
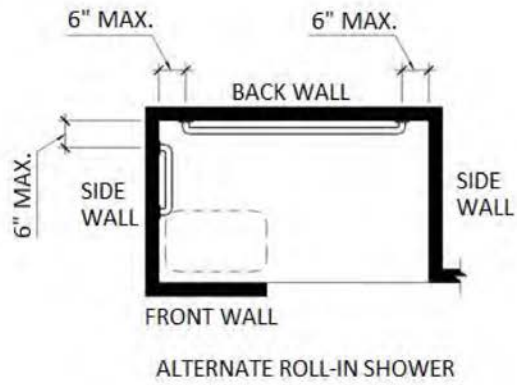

(a) GRAB BARS

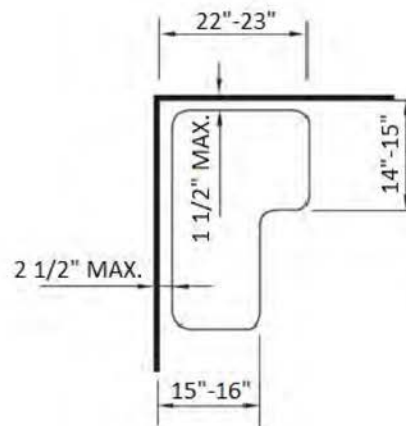
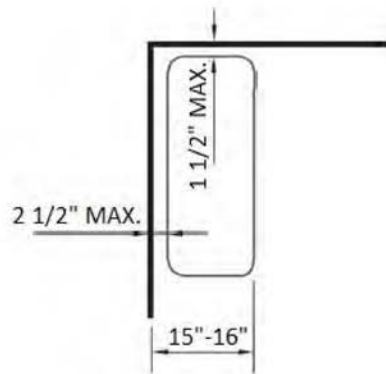

(b) SHOWER SEATS

FIGURE 1A-9I
SHOWER SEATS AND GRAB BARS