



CITY OF HAWAIIAN GARDENS
 DEPARTMENT OF COMMUNITY DEVELOPMENT
 BUILDING AND SAFETY DIVISION
**ACCESSIBILITY DETAILS FOR
 CURBS**

INFORMATION
 BULLETIN
A-007

Effective: 6-15-12
 Revised:
 Sheet 1 of 3

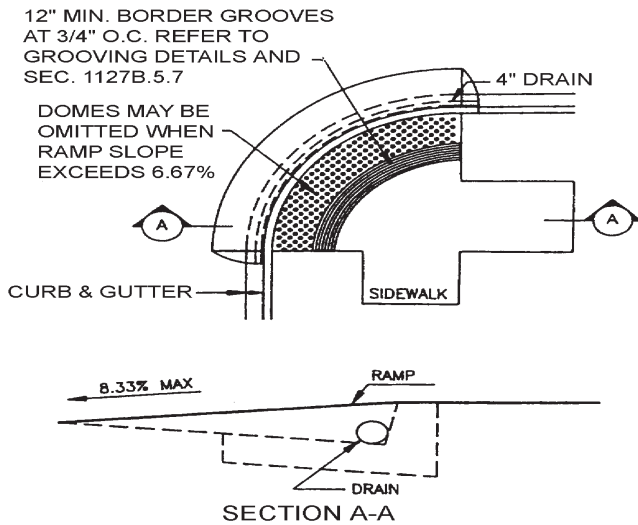

FIGURE 11B -19A -CURB DETAILS

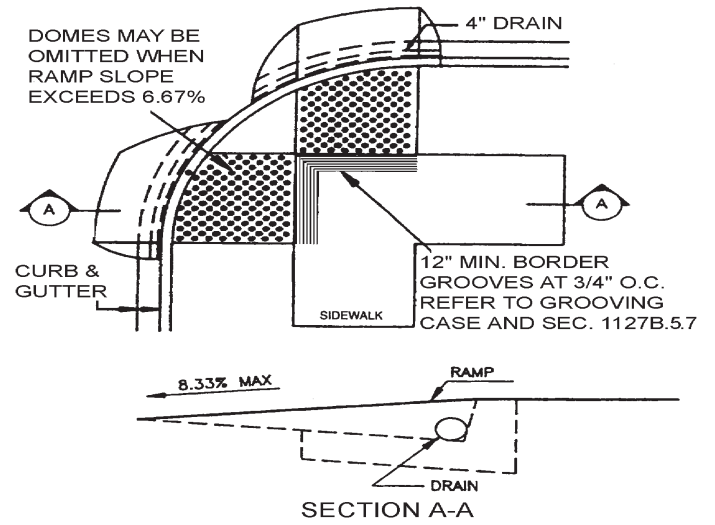

FIGURE 11B -19B -CURB DETAILS

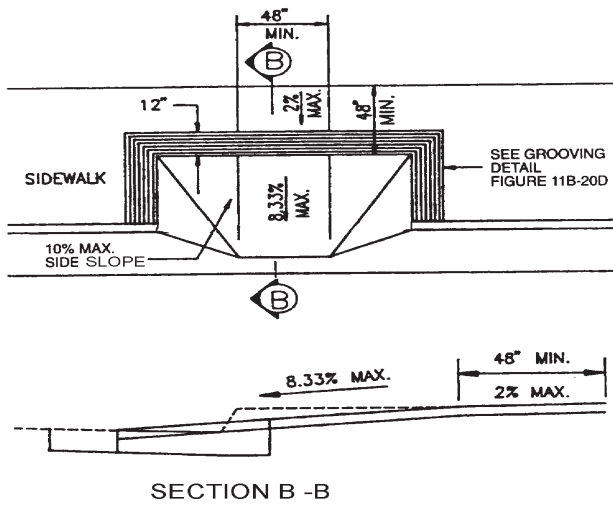

FIGURE 11B -19C -CURB DETAILS

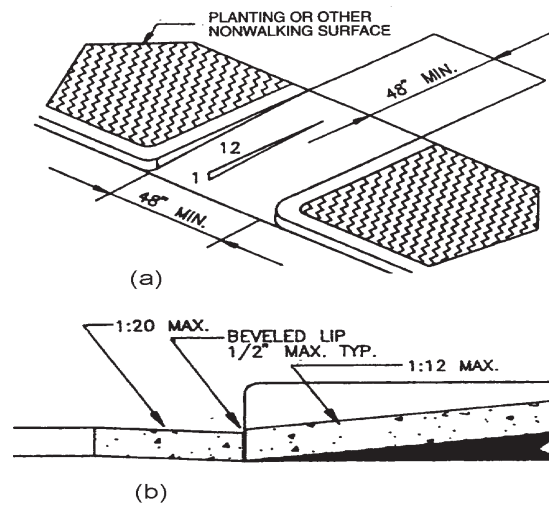

FIGURE 11B -21 -RETURNED CURB STYLE

CURB RAMP

THESE DIAGRAMS ILLUSTRATE THE SPECIFIC REQUIREMENTS OF THESE REGULATIONS AND ARE INTENDED ONLY AS AN AID FOR BUILDING DESIGN AND CONSTRUCTION.

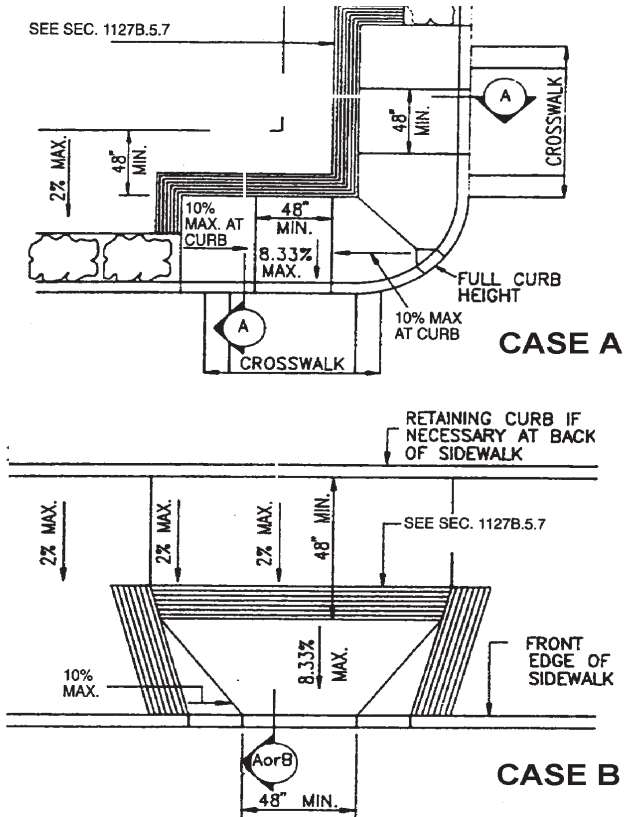

FIGURE 11B -20 A -CURB DETAILS

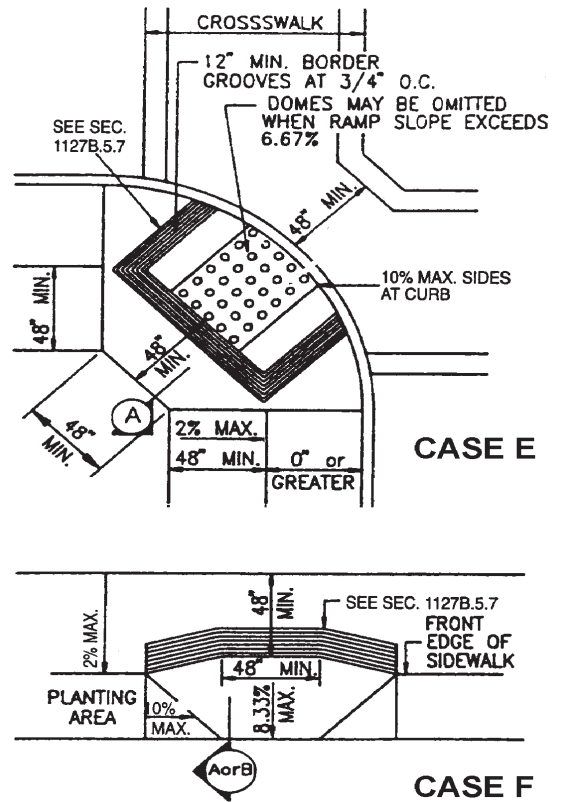
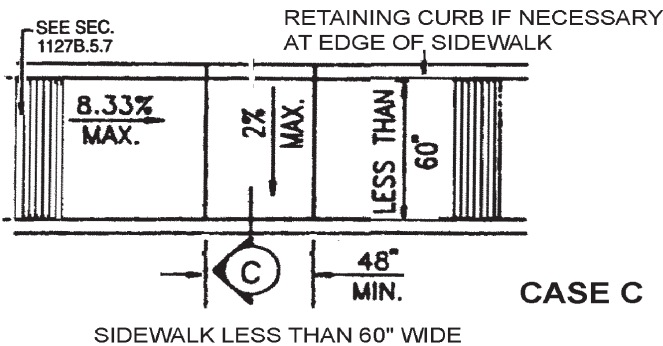
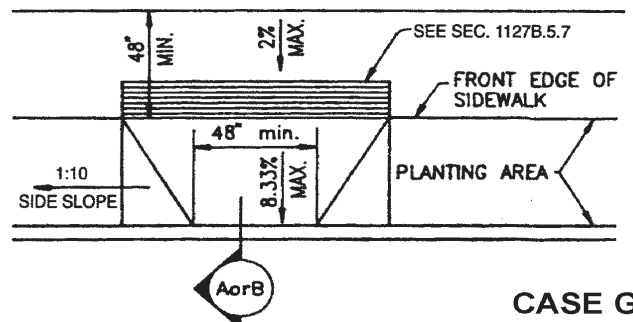

FIGURE 11B -20C -CURB DETAILS



CASE C



CASE G

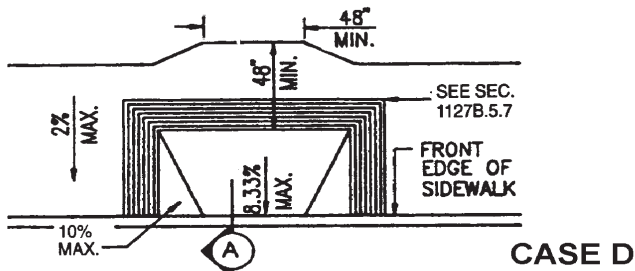

CASE D

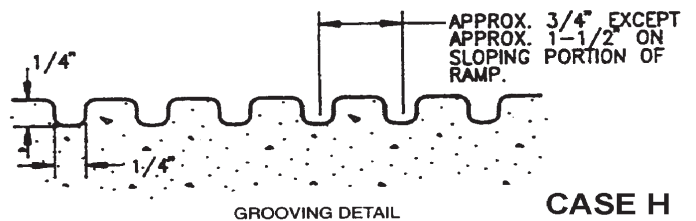

CASE H

FIGURE 11B- 20B -CURB DETAILS

FIGURE 11B -20D -CURB DETAILS

CURB RAMP

THESE DIAGRAMS ILLUSTRATE THE SPECIFIC REQUIREMENTS OF THESE REGULATIONS AND ARE INTENDED ONLY AS AN AID FOR BUILDING DESIGN AND CONSTRUCTION.

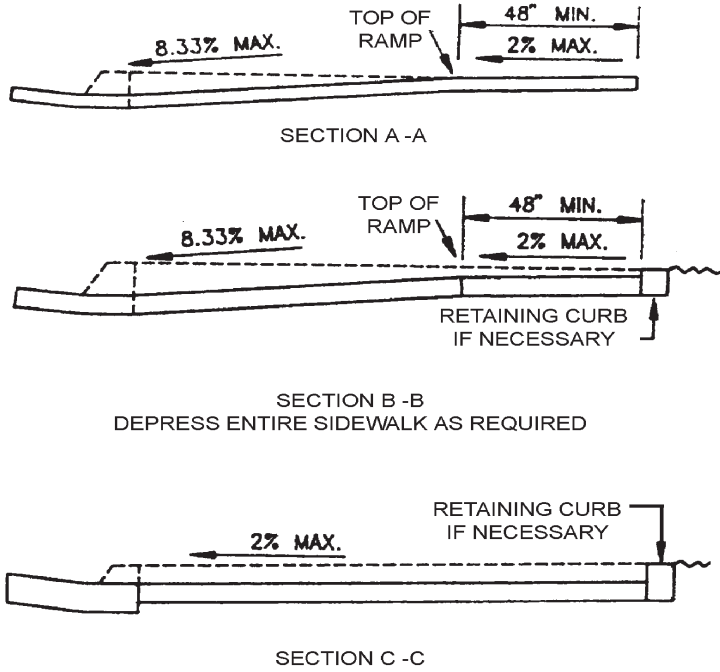

FIGURE 11B -20E -CURB SECTIONS

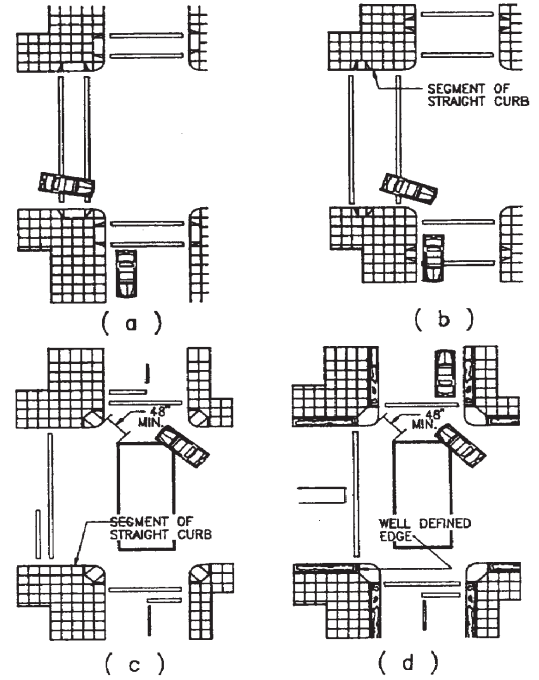

FIGURE 11B -22 -CURB RAMPS AT MARKED CROSSING

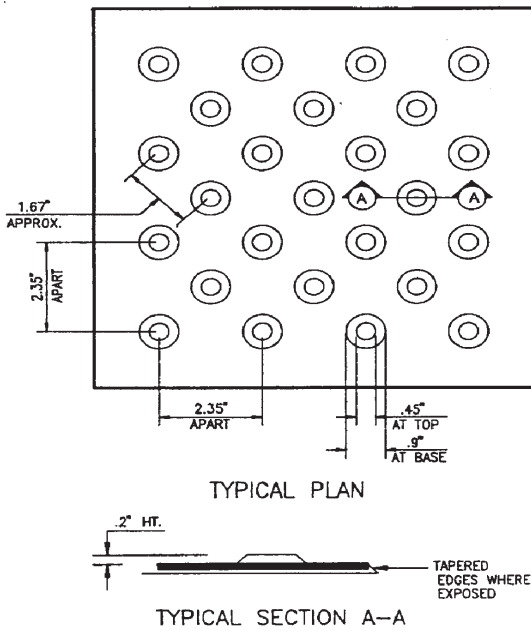

FIGURE 11B -23A TRUNCATED DOMES

*NOTE: INDUSTRY STANDARD FOR OVERALL BAR LENGTH IS 11-1/4\"/>

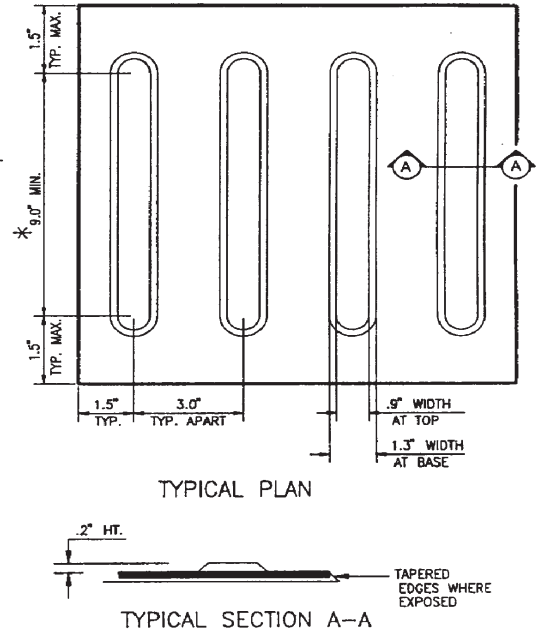

FIGURE 11B -23B DIRECTIONAL BARS

R